



* 3 E R W 2 *

3	E	R	W	2
---	---	---	---	---

↑
請把電腦條碼貼在方格內
Please stick the barcode label in the box.

Education Bureau Territory-wide System Assessment 2024 Primary 3 English Language Reading & Writing

Instructions:

學生須知：

1. Stick barcode labels on pages 1, 3 and 5 in the spaces provided.
在第 1、3 及 5 頁的適當位置貼上電腦條碼。
2. There are 4 parts in this Question-Answer Booklet.
Answer all questions.
本卷共有 4 部分，全部題目均須作答。
3. Do not write in the margins.
請勿在框線以外書寫。
4. Time allowed is 30 minutes.
評估時限為 30 分鐘。
5. Write your School Code, Class and Class Number in the boxes below.
在下面的方格內填寫學校編號、班別及班號。

Instructions for answering questions:

作答說明：

Multiple Choice Questions – Blacken the circle next to the correct answer with an **HB pencil**. For example:

選擇題 – 選出正確的答案，並用 **HB 鉛筆** 把該選項的圓圈塗黑和塗滿，如：

- | | | | | |
|-------------------------------------|----|-------------------------------------|--|--------------------------|
| <input checked="" type="radio"/> A. | | <input checked="" type="radio"/> A. | | <input type="radio"/> B. |
| <input type="radio"/> B. | or | <input type="radio"/> C. | | <input type="radio"/> D. |
| <input type="radio"/> C. | 或 | <input type="radio"/> A. | | |
| <input type="radio"/> D. | | | | |

Other Questions – Write your answers in the spaces provided.

其他題目 – 在適當的位置內填寫答案

School Code
學校編號

P			
---	--	--	--

Class
班別

3	
---	--

Class No.
班號

--	--

↑
此格只許填寫一個大楷英文字母
Write one capital letter in this box.

請把電腦條碼貼在方格內
Please stick the barcode label in the box.

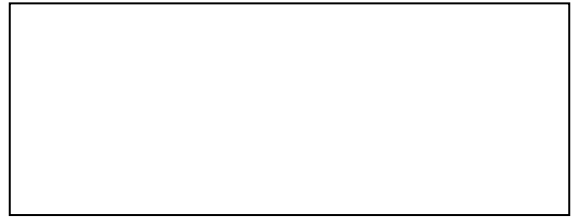

3. Joe's brother is 6 years old. He can join the _____ Class.



A.

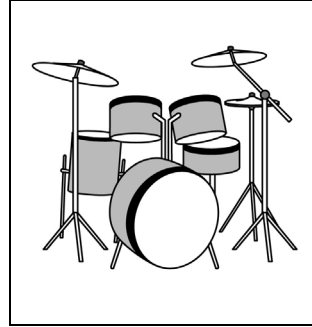

B.

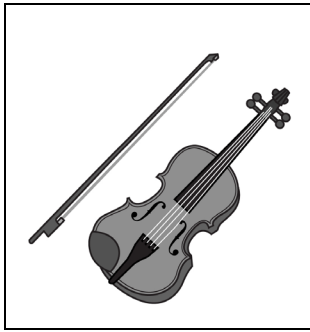

C.

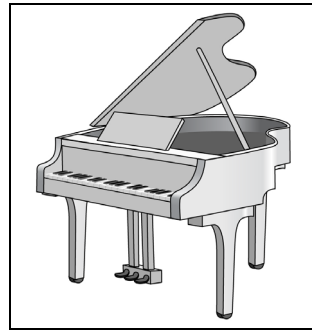

D.

4. Who teaches two classes?

A. Miss Lee

B. Mr Chan

C. Miss Ho

D. Mr Wong

5. Joe joins the Violin Class. He pays _____.

A. \$250

B. \$300

C. \$500

D. \$600

Please do not write in the margin. 請勿在此書寫。

Please do not write in the margin. 請勿在此書寫。

Part 2

Joe is writing some notes about the four seasons.

Read the notes.

Spring

Spring comes in March. People like to go to the park because they can have a picnic there. There are many trees and flowers. They are beautiful.

1

Summer

Summer holidays start in July and end in August. The weather is hot. People swim at beaches and in swimming pools.

5

Autumn

The Mid-Autumn Festival is in September this year. People eat mooncakes. They look at the colourful lanterns and lights. The weather is cool. People like to go hiking in the hills.

10

Winter

The cold weather starts in December. People can see Christmas trees in shopping centres. They also hold parties and eat hotpot at home.

15

Choose the best answer by blackening the circle.

1. Why do people go to the park in spring?
 - A. They can eat hotpot.
 - B. They can eat mooncakes.
 - C. They can have a picnic.
 - D. They can hold parties.
2. Read line 4. The word 'They' refers to _____.
 - A. the trees and flowers
 - B. the people
 - C. the lanterns and lights
 - D. the hills

請把電腦條碼貼在方格內
Please stick the barcode label in the box.



3. In summer, people go to _____.
- A. hills and parks
 - B. parties and parks
 - C. beaches and swimming pools
 - D. shopping centres and friends' homes
4. This year, the Mid-Autumn Festival is in _____.
- A. March
 - B. July
 - C. August
 - D. September
5. In autumn, people like to _____.
- A. go hiking
 - B. go swimming
 - C. plant trees
 - D. look at flowers
6. In winter, people can see _____ in shopping centres.
- A. colourful lanterns
 - B. Christmas trees
 - C. trees and flowers
 - D. mooncakes

Please do not write in the margin. 請勿在此書寫。

Please do not write in the margin. 請勿在此書寫。

Part 3

Joe is reading a story.

Read the story.



A Big Kiss



1

Today is Lisa's birthday. Lisa is sad because no one remembers her birthday. Her parents are busy. Mum does the housework all morning. Dad works in many places like Canada, France and Korea. Now, he works in Japan.

5

At noon, Mum asks Lisa to go to buy eggs and fruit. When she gets back home, she sees her friends. They wear party hats and hold balloons. There are birthday cards, sandwiches and drinks on the table, but there is no cake.

Then, Lisa's friends sing a birthday song to her. They also give her gifts. But she feels down. She misses Dad and starts to cry.

10

The doorbell rings. Lisa opens the door. She gets a birthday cake from a man. The man wears sunglasses and a mask. He then takes them off. Lisa shouts, "It's Dad!" She gives him a big kiss. Everyone claps happily.

15

Choose the best answer by blackening the circle.

1. Read lines 2 – 3. Why is Lisa sad?
 - A. No one remembers her birthday.
 - B. She is busy.
 - C. Mum tells her to do the housework.
 - D. She cannot see her friends.

Please do not write in the margin. 請勿在此書寫。

Please do not write in the margin. 請勿在此書寫。

Please do not write in the margin. 請勿在此書寫。

2. Dad works in _____ now.

A. Canada

B. France

C. Japan

D. Korea

3. Lisa's friends hold _____ in their hands.

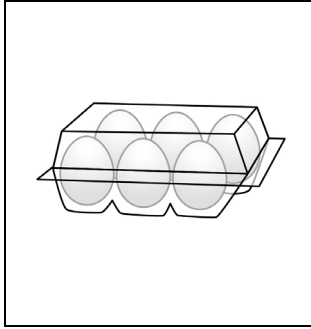

A.

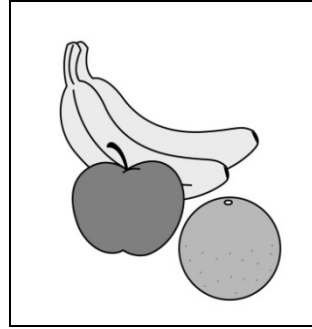

B.

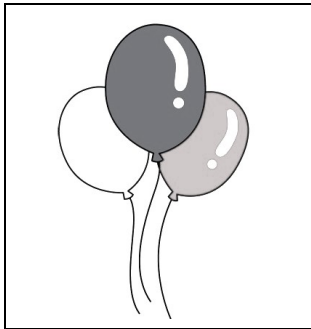

C.

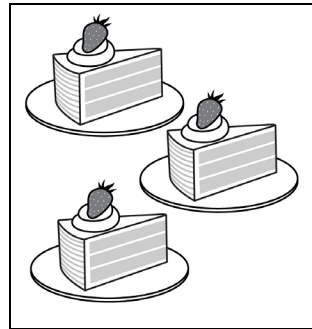

D.

Please do not write in the margin. 請勿在此書寫。

4. Lisa does not see _____ on the table.



A.



B.

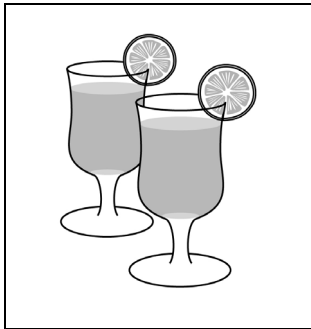

C.

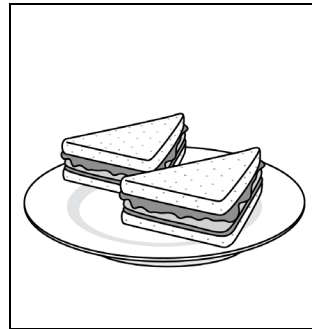

D.

5. What do Lisa's friends do? They _____.

- 1) buy a cake
- 2) give Lisa gifts
- 3) sing a birthday song
- 4) shout at Lisa

A. 1 and 2

B. 2 and 3

C. 1 and 4

D. 3 and 4

6. Read line 11. The word 'down' means _____.

- A. busy
- B. happy
- C. hungry
- D. sad

7. Read line 15. The word 'them' refers to _____.

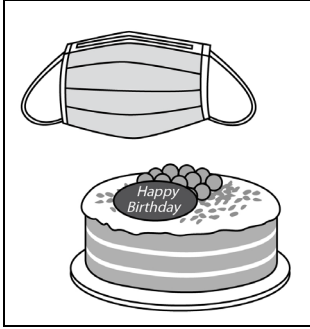

A.

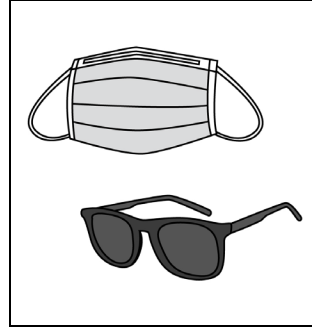

B.



C.

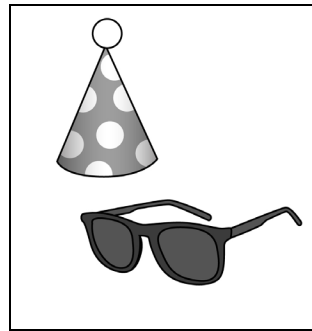

D.

8. Lisa gives Dad a _____.

- A. balloon
- B. hat
- C. mask
- D. kiss

Part 4

You are writing a story about Susan and her dad.

Look at the pictures and write the story in about 30 words.

- ◆ You may use the words in the boxes to help you.
- ◆ What happens in the end? Finish the story.

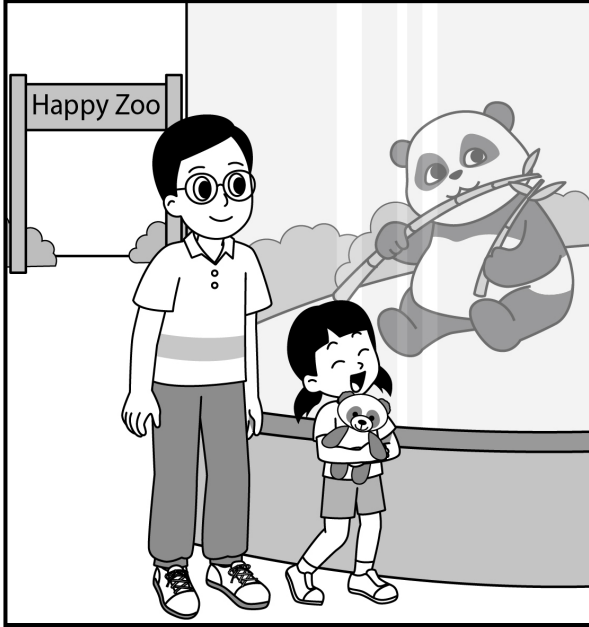

visit / panda

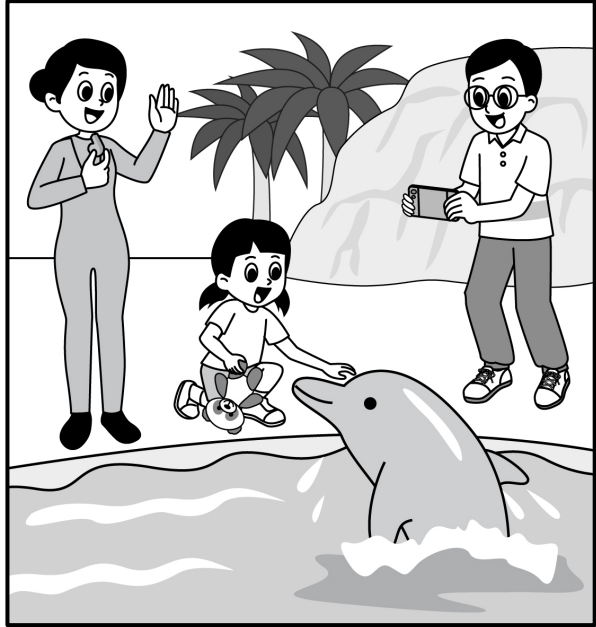

touch / dolphin

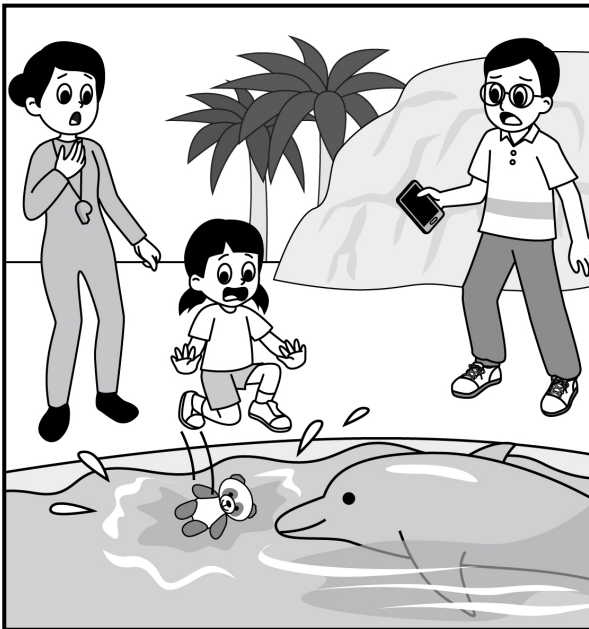

drop / water

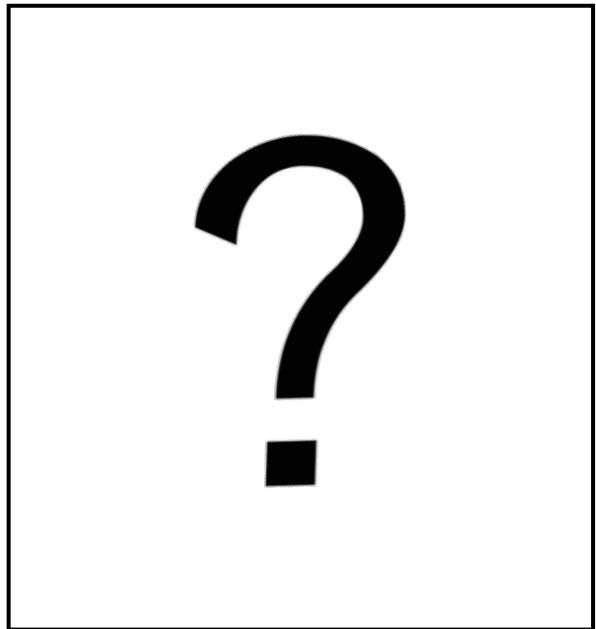

Please do not write in the margin. 請勿在此書寫。

Please do not write in the margin. 請勿在此書寫。

